

Specification Information Sheet

RTE100L

RainTrak 100mm wide, variable depth channel with Linéaire grate

Specification clause

The floor channel and grates are to be type RTE100L (100mm wide, variable depth channel with Linéaire grates) grade 304/316 stainless steel, as supplied by ACO Pty Ltd. The channel will be supplied with an enclosed sill section, made to suit as per dimensions on drawing number _____.

The channels overall depth, length, outlet position/s and outlet diameter/s are specified on drawing number/s _____.

All components used within the scope of the systems are shown on drawing number/s _____. All work should be carried out strictly in accordance with the manufacturers instructions and the installation details set out on drawing number/s _____.

www.acobuildline.com.au

Ph: 1300 765 266 (Australia)

Ph: +61 2 4747 4000 (International)

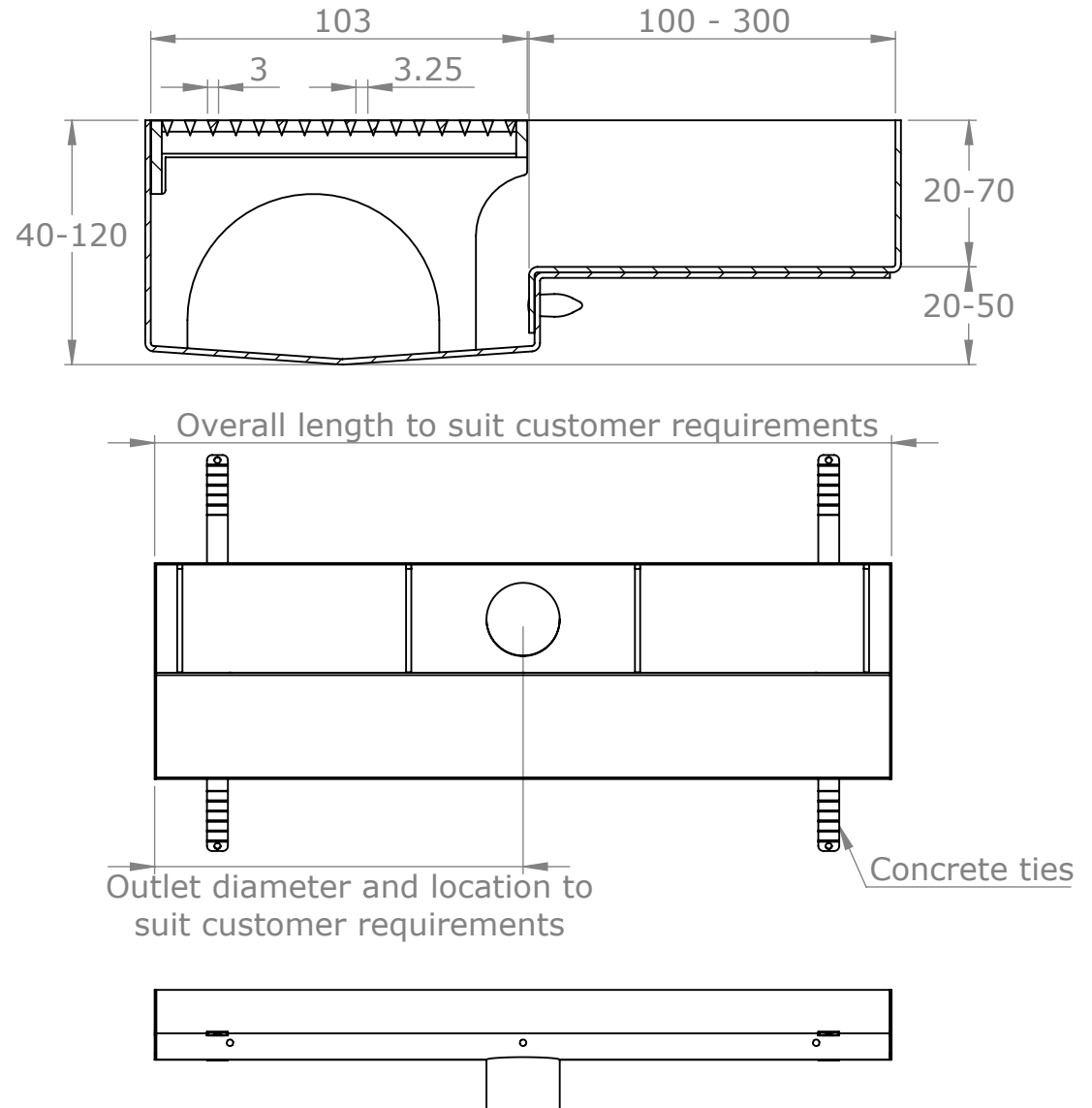

*All dimensions in mm